

Article number: 437900150

Description: Rota-fix shaft-hub connection SA 150

Measures

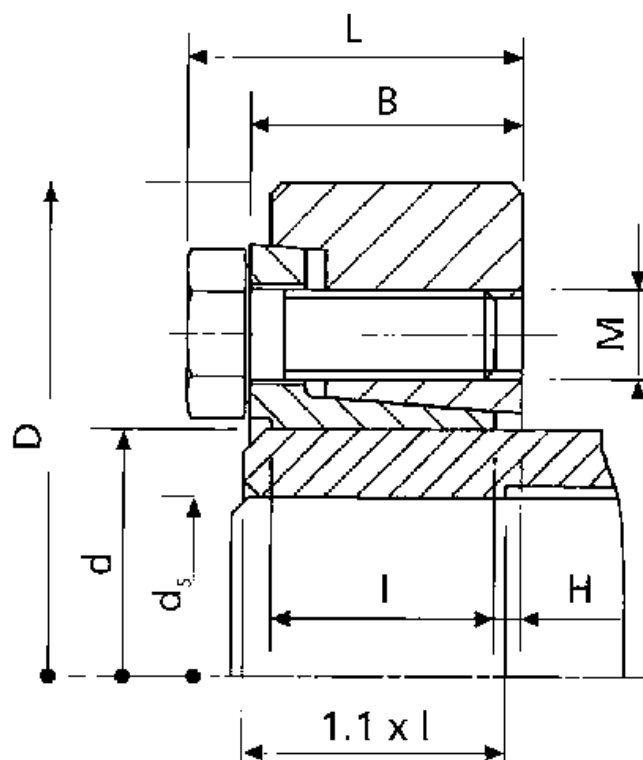

B mm	= 63.0
d H8 mm	= 150
D mm	= 263.0
ds mm	= 110
F kN torque	= 491
H	= 7.5
I mm	= 51.0
L mm	= 72.0

M mm	= M14
T N m torque	= 27000
Ts N m bolt tightening torque	= 160